

heroyal D 72

Front Door System



Front Door Systems

First-class materials, technical perfection down to the smallest detail and a wide variety of design options are the unique characteristics of heroal's efficient system technology. Advantages that are convincing. For decades, heroal has been the reliable partner for architects, builders and fabricators, offering innovative solutions for the building shell made from aluminium and aluminium composites.

Planners appreciate the wide range of versatile design options, builders are able to create individual requirements with a reliable system, and our partners benefit from economically efficient heroal system solutions.

The system heroal D 72 offers functional versatility and sophisticated designs, achieves perfect insulation values and meets the highest static requirements. The certified, reliable heroal system is suitable for all standard opening variants, including automatic door systems and burglary resistant front doors - also with emergency exit function.

Explore the variety of the front door systems heroal D 72!





heroal D 72

Page 4

Door system offering great flexibility

heroal D 72 RL

Page 5

Door system with roundline outer contour

heroal D 72 CL

Page 6

Door system with chamfered outer contour

Door types and opening variants

Page 7

Sash and design variants

Page 8

heroal technologies

Page 10

Threshold solutions

Page 12

System dimensions and system features

Page 13

Service

Page 14

heroal D 72

Door system offering great flexibility

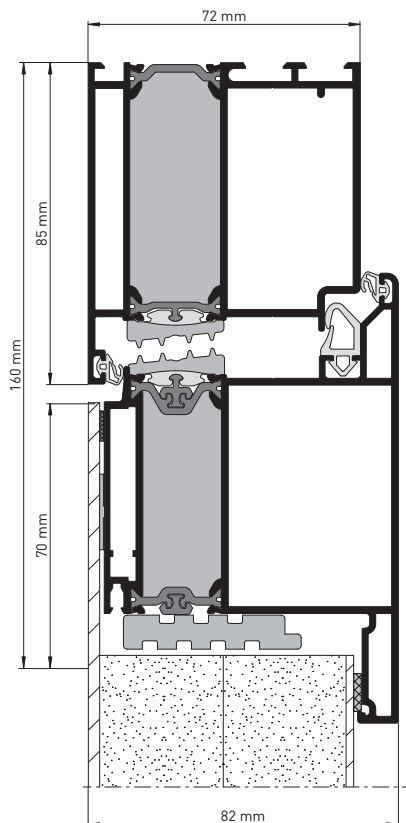
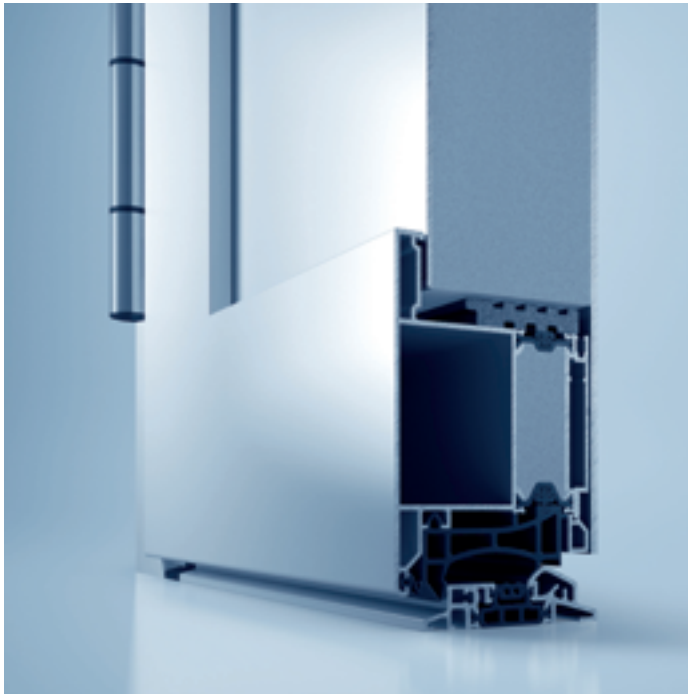

heroal D 72, cross section

The front door system heroal D 72 offers a great design variety within one system. At the same time, the performance features of this front door system can be adapted to the individual technical requirements of a building. The system covers a unique spectrum of thermal insulation, wind load resistance, air permeability and thresholds. heroal fabricators do not only benefit from this great flexibility, but also from a consistent system logic and enhanced production reliability.

System dimensions and system features

- » design depth: 72 mm (frame/bars), 65-72 mm (sash)
- » variable face widths: frame 60-250 mm, sash 56-124 mm, bars 70-254 mm
- » smallest combinable face width: 145 mm
- » max. sash width/ height: 1,400 mm/ 3,000 mm
- » max. sash weight: 180 kg
- » max. thickness of glass /infill panel: frame up to 54 mm, sash up to 68 mm (glass) and 72 mm (panel)
- » thermal insulation: $U_f > 1.7 \text{ W/m}^2\text{K}$ (meeting all requirements of GEG 2020, the German Buildings Energy Act)
- » air permeability: 4
- » tightness against driving rain: up to E900
- » wind load resistance: C4
- » soundproofing: up to $R_w = 43 \text{ dB}$
- » certified burglary resistance up to resistance class RC 3
- » impact resistance: class 4
- » operating forces: class 2
- » mechanical strength: class 3
- » continuous function: up to class 8
- » behaviour between different climates: class 2 (d/e)
- » meeting requirements of load bearing capacity of safety devices
- » patented, warp-resistant compound profile

Design options

- » opening variants: single or multi-part elements with sidelights and toplights
- » single or multi-part formed elements with sidelights or toplight as segmental, round or basket arch
- » design variant heroal D 72 PF „Panel Fixed“ with fixed stop, no glazing strip required
- » all-round sash frame, with base, single or double-sided FüF
- » compatible window system: heroal W 72
- » integration into curtain wall system heroal C 50 HI possible (entrance curtain walls)
- » high-quality colour design with heroal hwr powder coating, heroal SD surface designs and Les Couleurs® Le Corbusier

heroyal D 72 RL

Door system with roundline outer contour

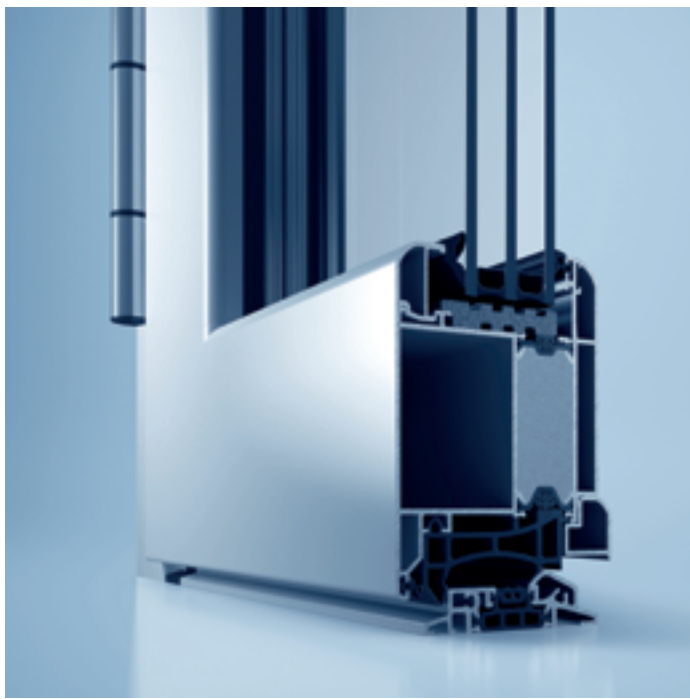

The front door system heroyal D 72 RL stands out for its harmonious roundline contour. The rounded outer contour ideally matches the style of old or listed buildings, which makes this system perfectly suited for restoration projects. heroyal D 72 RL offers the same excellent performance features as the front door system heroyal D 72.

System dimensions and system features

- » design depth: 72 mm (frame/bars), 65-72 mm (sash)
- » variable face widths: frame 60-250 mm, sash 56-124 mm, bars 70-254 mm
- » smallest combinable face width: 145 mm
- » max. sash width/ height: 1,400 mm/3,000 mm
- » max. sash weight: 180 kg
- » max. thickness of glass/infill panel: frame up to 54 mm, sash up to 68 mm (glass) and 72 mm (panel)
- » thermal insulation: $U_f > 1.7 \text{ W/m}^2\text{K}$ (meeting all requirements of GEG 2020, the German Buildings Energy Act)
- » air permeability: 4
- » tightness against driving rain: up to E900
- » wind load resistance: C4
- » soundproofing: up to $R_w = 43 \text{ dB}$
- » certified burglary resistance up to resistance class RC 3
- » impact resistance: class 4
- » operating forces: class 2
- » mechanical strength: class 3
- » continuous function: up to class 8
- » behaviour between different climates: class 2 (d/e)
- » meeting requirements of load bearing capacity of safety devices
- » patented, warp-resistant compound profile

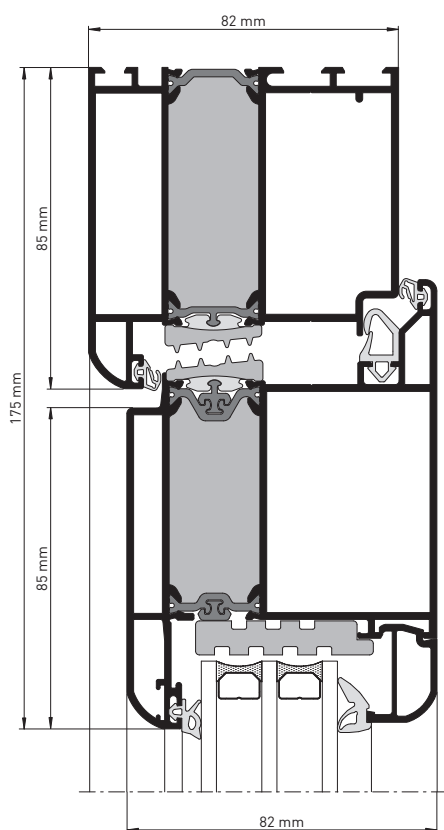

Design options

- » opening variants: single or multi-part elements with sidelights and toplights
- » single or multi-part formed elements with sidelights or toplight as segmental, round or basket arch
- » design variant heroyal D 72 PF „Panel Fixed“ with fixed stop, no glazing strip required
- » all-round sash frame, with base, single or double-sided FÜF
- » front door system compatible with profile: heroyal D 72
- » compatible window system: heroyal W 72 RL
- » integration into curtain wall system heroyal C 50 HI possible (entrance curtain walls)
- » high-quality colour design with heroyal hwr powder coating, heroyal SD surface designs and Les Couleurs® Le Corbusier

heroal D 72 CL

Door system with chamfered outer contour

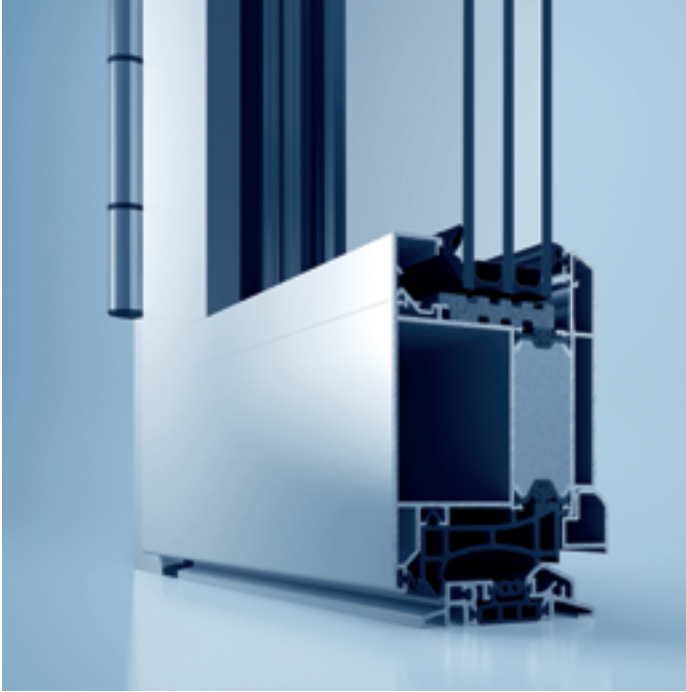

The front door system heroal D 72 CL captivates with its elegant classicline contour. The chamfered outer contour is the ideal solution for buildings in a classical style. heroal D 72 CL offers the same excellent performance features as the front door system heroal D 72.

System dimensions and system features

- » design depth: 72 mm (frame/bars), 65-72 mm (sash)
- » variable face widths: frame 60-250 mm, sash 56-124 mm, bars 70-254 mm
- » smallest combinable face width: 145 mm
- » max. sash width/ height: 1,400 mm/3,000 mm
- » max. sash weight: 180 kg
- » max. thickness of glass/infill panel: frame up to 54 mm, sash up to 68 mm (glass) and 72 mm (panel)
- » thermal insulation: $U_f > 1.7 \text{ W/m}^2\text{K}$ (meeting all requirements of GEG 2020, the German Buildings Energy Act)
- » air permeability: 4
- » tightness against driving rain: up to E900
- » wind load resistance: C4
- » soundproofing: up to $R_w = 43 \text{ dB}$
- » certified burglary resistance up to resistance class RC 3
- » impact resistance: class 4
- » operating forces: class 2
- » mechanical strength: class 3
- » continuous function: up to class 8
- » behaviour between different climates: class 2 (d/e)
- » meeting requirements of load bearing capacity of safety devices
- » patented, warp-resistant compound profile

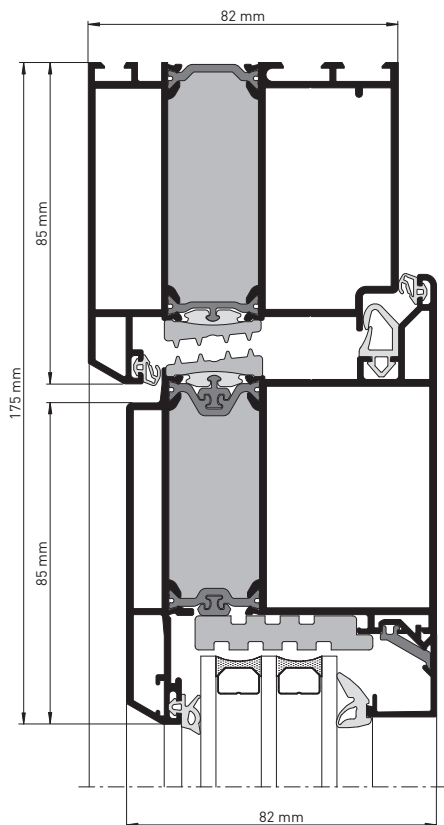

Design options

- » opening variants: single or multi-part elements with sidelights and toplights
- » single or multi-part formed elements with sidelights or toplight as segmental, round or basket arch
- » design variant heroal D 72 PF „Panel Fixed“ with fixed stop, no glazing strip required
- » all-round sash frame, with base, single or double-sided FÜF
- » front door system compatible with profile: heroal D 72
- » compatible window system: heroal W 72 RL
- » integration into curtain wall system heroal C 50 HI possible (entrance curtain walls)
- » high-quality colour design with heroal hwr powder coating, heroal SD surface designs and Les Couleurs® Le Corbusier

Door types and opening variants

Flexible designs for all requirements

Single sash elements with sidelights and toplights

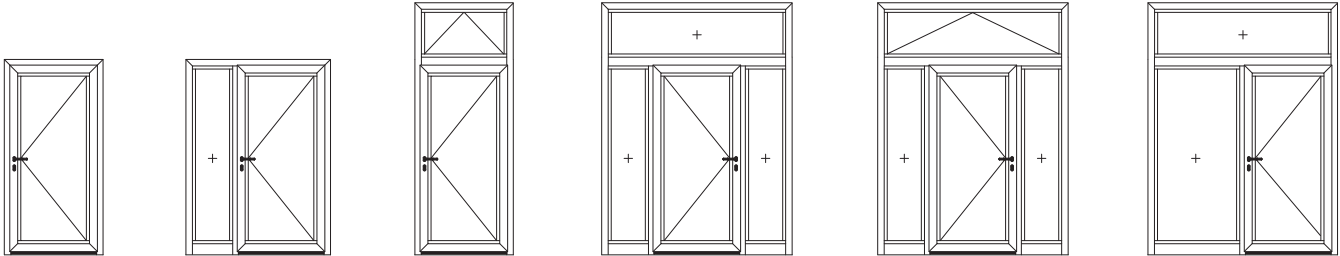

Double sash elements with sidelights and toplights

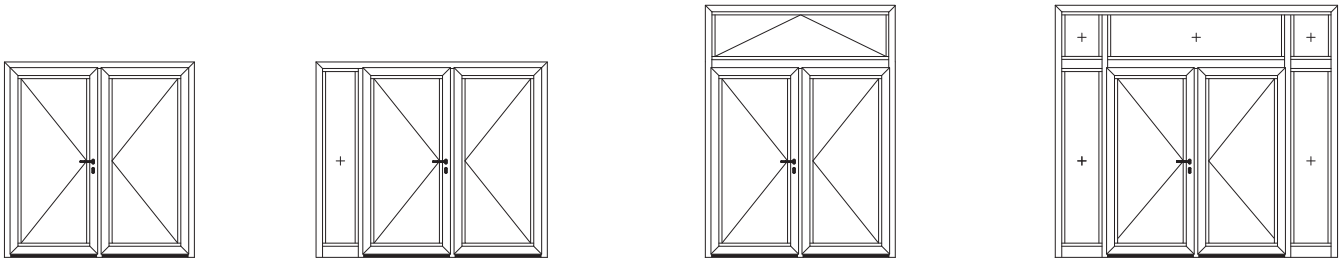

Special forms with one or two sashes

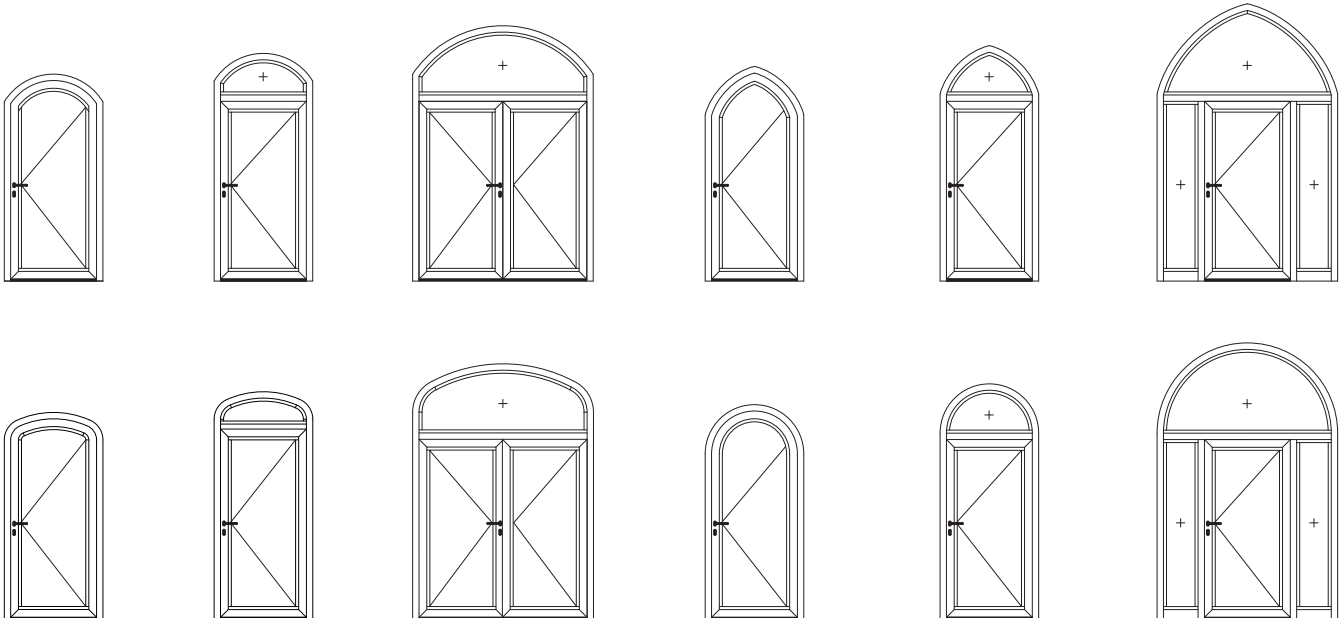

Sash and design variants

Wide range of variants

The wide range of design options and an extremely efficient production are two of the major characteristics of the front door system heroal D 72. Sash profiles for infill panels, single or double-sided sash-concealing panels, as well as sash-concealing panels for door elements with two sashes provide for the manufacture of a wide variety of designs. heroal further extends this freedom of design for its premium segment with heroal D 72

PF (Panel Fixed) sash profiles, which offer a fixed inside stop instead of a glazing strip, and sash profiles for 6 mm motif panels. Also, it is possible to design all sash-concealing panels as a flush or recessed variant. The innovative, certified attachment technology with reversible panel attachment grants even more freedom of design, and helps to save time.

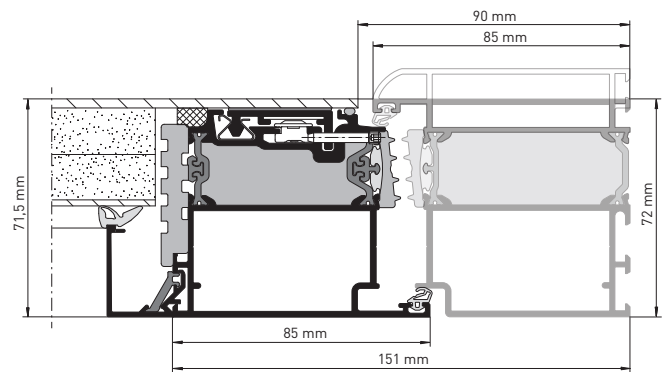
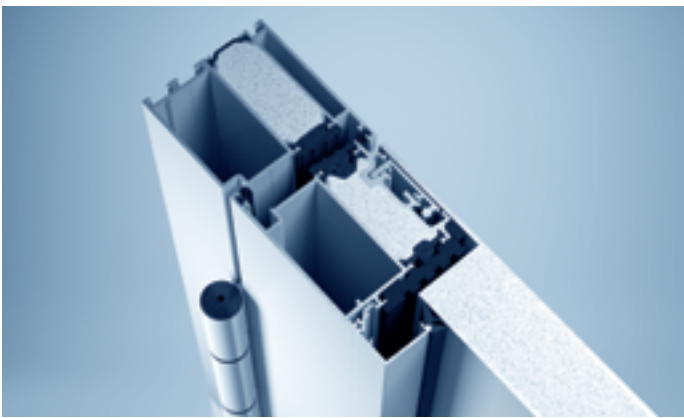

single-sided sash-concealing, reversible

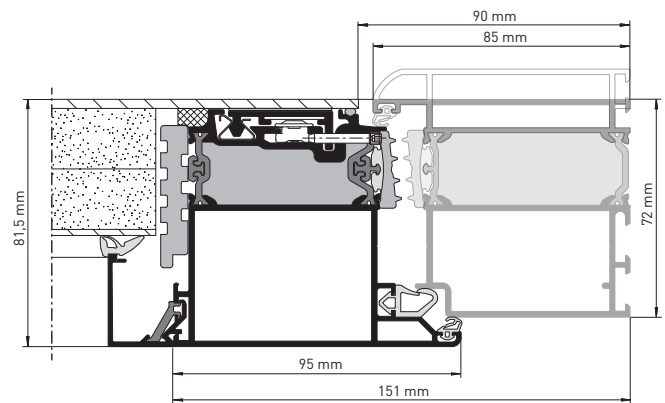
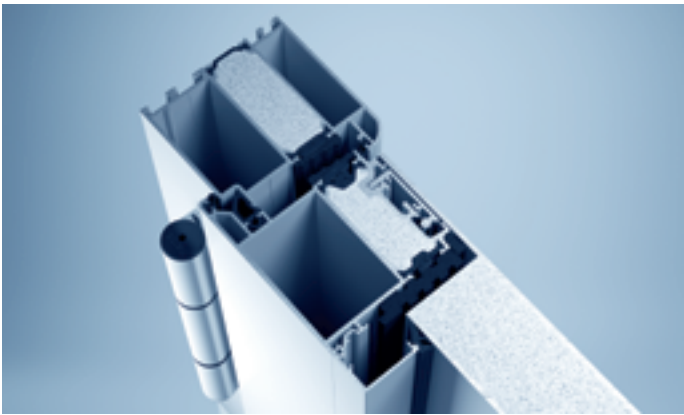

single-sided sash-concealing, reversible

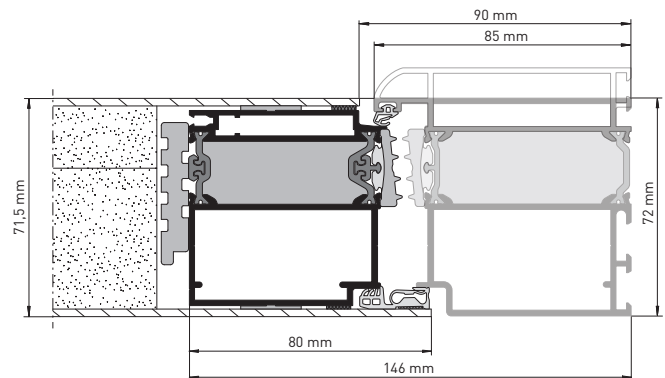
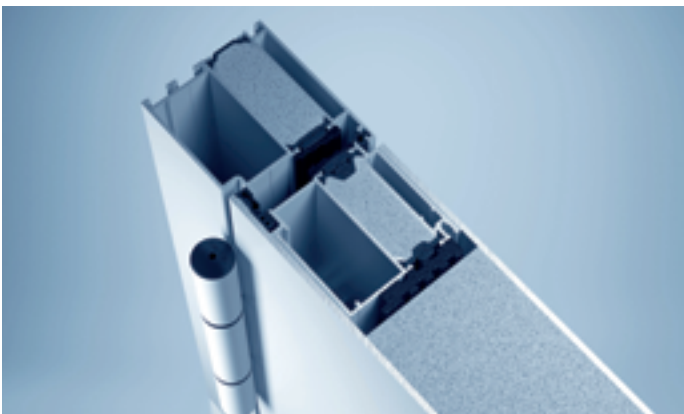

double-sided sash-concealing

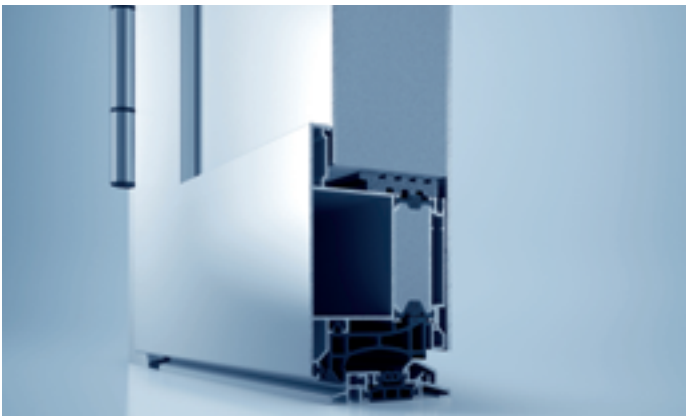

Sash without glazing strip

The wide variety of designs is further extended with the sash profiles heroal D 72 PF (Panel Fixed) for one-sided sash-concealing panels. heroal D 72 PF profiles have a fixed stop and do not require a glazing strip. This reduces the material input and also saves time, resulting in shorter lead times in manufacture. As an option, heroal offers all sash-concealing panel variants, whether for outside or inside applications, with a flush or recessed design.

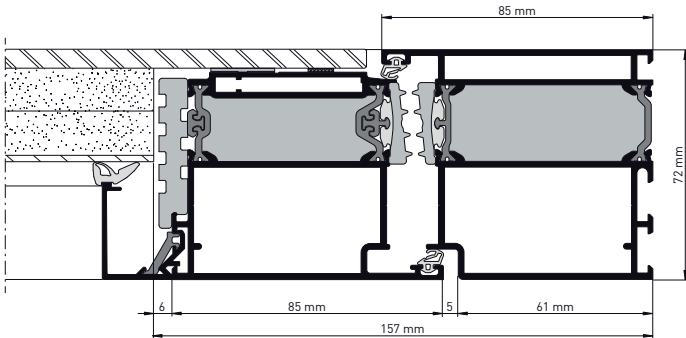

Sashes for motif panels

The design options for front door panels are unlimited: glass, glazed inserts, aluminium panels or motif panels in countless colours and designs are available. heroal also offers suitable, modern aluminium sash profiles for authentic front door panels made from matured timber or panels with a hard-wearing ceramic surface.

heroal technologies

For optimised and time-saving manufacture



heroal corner angle technology

The innovative heroal sealant injection ensures the optimal sealing of the mitre joints of the elements, while requiring only low material input. At all four sides, the corner connectors are completely covered with sealant, providing for even more system reliability. An efficient and time-saving manufacture of doors is made possible through heroal's corner connector technology, which enhances the production process during the installation of the corner angles. The perfectly guided distribution of sealant and the innovative corner angle geometries lead to considerable material savings. heroal expandable corner angles support the alignment of mitre-cut aluminium profiles, so that the manufacture and processing of doors is made easy and fast, without the need for any additional realignments.



heroal T-connector technology

The optimised and time-saving production of doors is made possible by heroal's T-connector technology. The innovative heroal sealant injection has been developed for an optimal sealing of T-connections and joints. The use of closed-cell foam rubber to seal the rebate ensures high system reliability. The innovative heroal sealant injection stands for perfectly sealed T-connectors and joints, requiring only low material input.



heroal compound technology

By means of three innovative production steps, the front door system heroal D 72 offers effective protection against the bimetal effect, which might cause warping of the sash frame due to considerable differences in temperature between the inside and outside. The patented, warp-resistant heroal profile compound, consisting of an inserted, tight insulating strip and a slide-in spring, protects the profile against potentially damaging shear forces.



heroal fitting technology

The fitting technology heroal DF ensures a great flexibility, since it is based on a universal design concept that can be adapted to the individual requirements of the user at any time. It also stands out for its intuitive operation and easy usability. heroal door fittings are compatible with sophisticated techniques, such as keyless entry and Bluetooth, which further increase the ease of use. The high-quality, aesthetically appealing hinge technology offers a wide range of barrel and surface hinges, and also a concealed solution.



Reversible panel attachment

For its front door system heroal D 72, heroal offers a reversible panel attachment - an innovation in the aluminium sector. This way of attaching the panel to the sash is made by way of joining and has received RC 2 and RC 3 certification. The reversible panel attachment is suitable for the sash profiles heroal D 72, heroal D 72 CL, heroal D 72 RL and heroal D 72 PF. This way of attaching the panel to the sash, without the need of any bonding technique using 2K adhesives, saves time and makes the fabrication easier and more process reliable. At the same time, fabricators benefit from shorter lead times.

Threshold solutions

For all requirements and uses

Perfection down to the detail: heroal offers an industry leading variety of threshold solutions meeting all standard requirements. All technical requirements and demands on design can be met, independent of opening type, inward or outward opening, with all-round sash frame or base profile. Furthermore, a wide range of base and connecting profiles allows for an easy integration into the building structure of both new and renovated buildings. The flexible heroal flat threshold with its continuous threshold design makes the creation of barrier-free solutions acc. to DIN

18040-2 possible. It is also possible to add an integrated drainage system (heroal DS) to barrier-free thresholds and zero-barriers (which are also eligible for subsidies granted by the German state-owned development bank Kfw). The retractable floor seal in combination with either one or two brush seals guarantees perfect tightness. A classic front door solution for elements with one or more sashes includes a screwed threshold with two sealing sections.

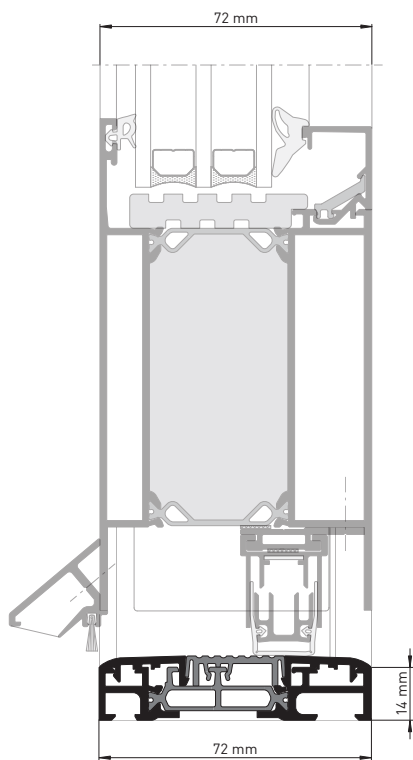
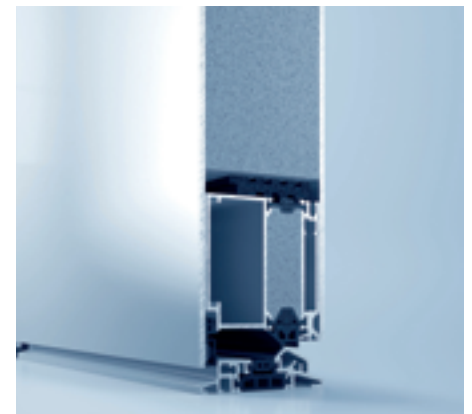
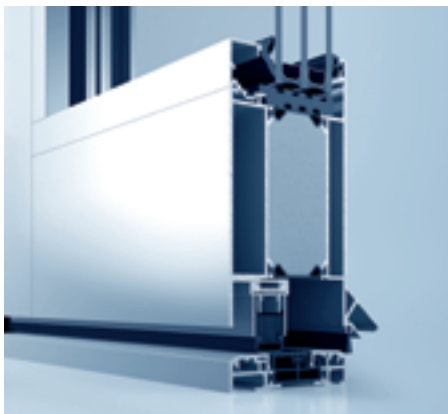

flat threshold with retractable floor seal

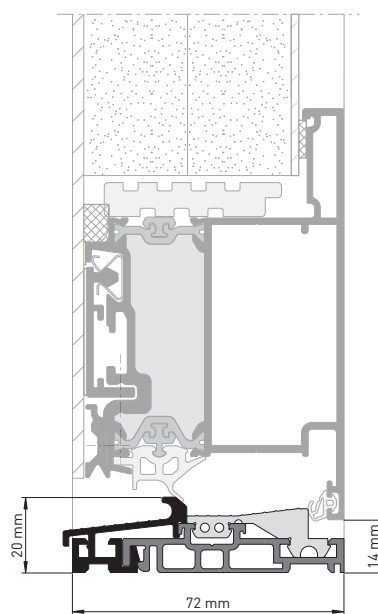

continuous threshold, 2-parts

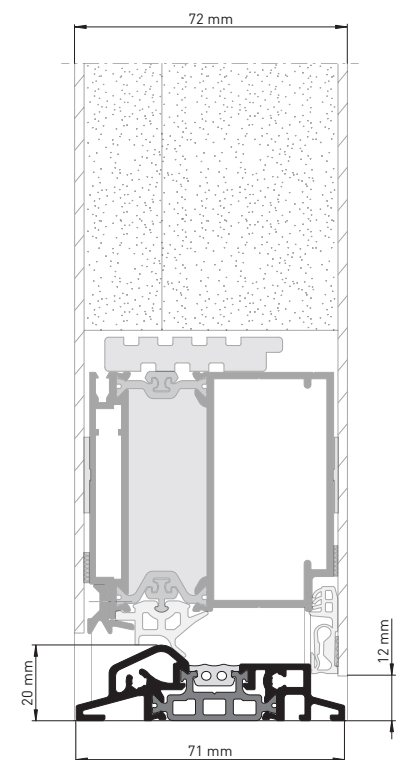

threshold with stop seal

System dimensions and system features

System dimensions

Description		heroal D 72	heroal D 72 RL	heroal D 72 CL
Profile design depth (mm)	Frame profiles	72	72-82	82
	Sash profiles	65-72	59-82	59-82
	Bar profiles	72	72-82	72-82
Profil face width (mm)	Frame profiles	60-250	60-154	60-154
	Sash profiles	56-124	56-100	56-85
	Bar profiles	70-254	70-94	74-94
Max. thickness of glass/infill panel (mm)	Frame profiles	54	54	54
	Sash profiles	68/72	68/72	68/72
Max. sash weight (kg)		180	180	180
Max. sash width (mm)		1,400	1,400	1,400
Max. sash height		3,000	3,000	3,000

System features

Description	heroal D 72	heroal D 72 RL	heroal D 72 CL
Wind load resistance	up to class C4	up to class C4	up to class C4
Tightness against driving rain	up to E 900	up to E 900	up to E 900
Impact resistance	class 4	class 4	class 4
Load bearing capacity of safety devices	requirements met	requirements met	requirements met
Soundproofing	up to $R_w=43$ dB	up to $R_w=43$ dB	up to $R_w=43$ dB
Thermal insulation (U_f in W/m^2K)	up to 1.7 W/m^2K	up to 1.7 W/m^2K	up to 1.7 W/m^2K
Thermal insulation (U_D in W/m^2K)	up to 1.0 W/m^2K	up to 1.0 W/m^2K	up to 1.0 W/m^2K
Air permeability	up to class 4	up to class 4	up to class 4
Operating forces	class 2	class 2	class 2
Mechanical strength	class 3	class 3	class 3
Continuous function	up to class 8	up to class 8	up to class 8
Behaviour between different climates	class 2 (d/e)	class 2 (d/e)	class 2 (d/e)
Burglary resistance	up to RC 3	up to RC 3	up to RC 3

Opening variants / door designs

Description	heroal D 72	heroal D 72 RL	heroal D 72 CL	heroal D 72 CL
Barrier-free elements	•	•	•	•
Curtain wall insert elements	•	•	•	•
Compatible heroal window system	heroal W 72	heroal W 72 RL	heroal W 72 CL	heroal W 72 CL
Emergency exits acc. to EN 179/1125 with CE-marking		•	–	–

heroal full service

Support along the entire process chain



01 Marketing and Sales

- > print media
- > advertising material
- > generation of leads
- > website kit
- > entrance door configurator
- > email marketing
- > events
- > exhibition concepts
- > personnel marketing



02 Planning and Quotation

- > planning tools
- > BIM-/CAD data
- > online configuration and ordering
- > electronic ordering (EDI)
- > LogiKal and PICOS support
- > project consulting
- > preparations for projects
- > digital product information and test certificates



06 Support and Service

- > heroal Communicator
- > heroal Academy
- > technical consulting

100 % supported. 100 % happy.

Success is when gears interlock, providing trouble-free team play. Therefore, we have created our service offer in a way to ideally support you and your work in every aspect. From marketing through planning and manufacture to application, our all-in service accompanies you along the entire process chain.

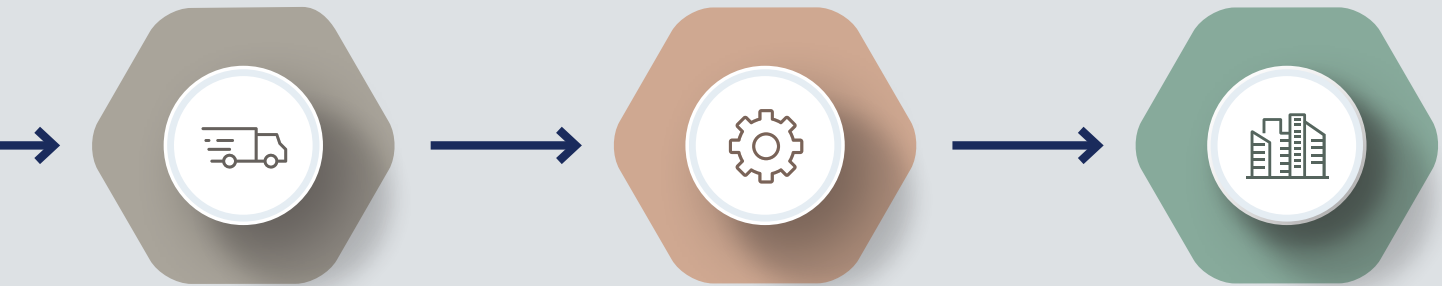

03 Logistics

- > shortest delivery times
- > highest adherence to schedules
- > delivery in consignments
- > personal contact with driver
- > project-related packing concepts
- > protective foil on profiles
- > acceptance of returned packing material

04 Manufacture

- > profile composite manufacture
- > surface coating
- > profile bending and sheet metal working
- > documented quality/quality street
- > cutting service
- > pre-fabricated assembly groups and finished elements
- > machines and tools
- > repair service for machines and tools

05 Application

- > heroal Smart Living
- > project references
- > reference shoots
- > digital maintenance instructions
- > support hotline
- > application technicians



heroal – the aluminium systems supplier

As a leading aluminium systems supplier, heroal develops and produces perfectly coordinated systems for windows, doors, curtain walls, roller shutters, roller doors and sun protection, complemented by folding and sliding shutters, insect screens, patio roofs and carports. By minimising energy consumption in production and maximising energy conservation in use, heroal system solutions make a vital contribution to the realisation of sustainable building – combined with maximum efficiency in the installation of the systems and the enhancement of the value of buildings.

Innovation, service, design, sustainability

The heroal brand stands for system solutions that combine practical innovations, industry-leading service and high-quality design that can be integrated into every architecture with sustainability.

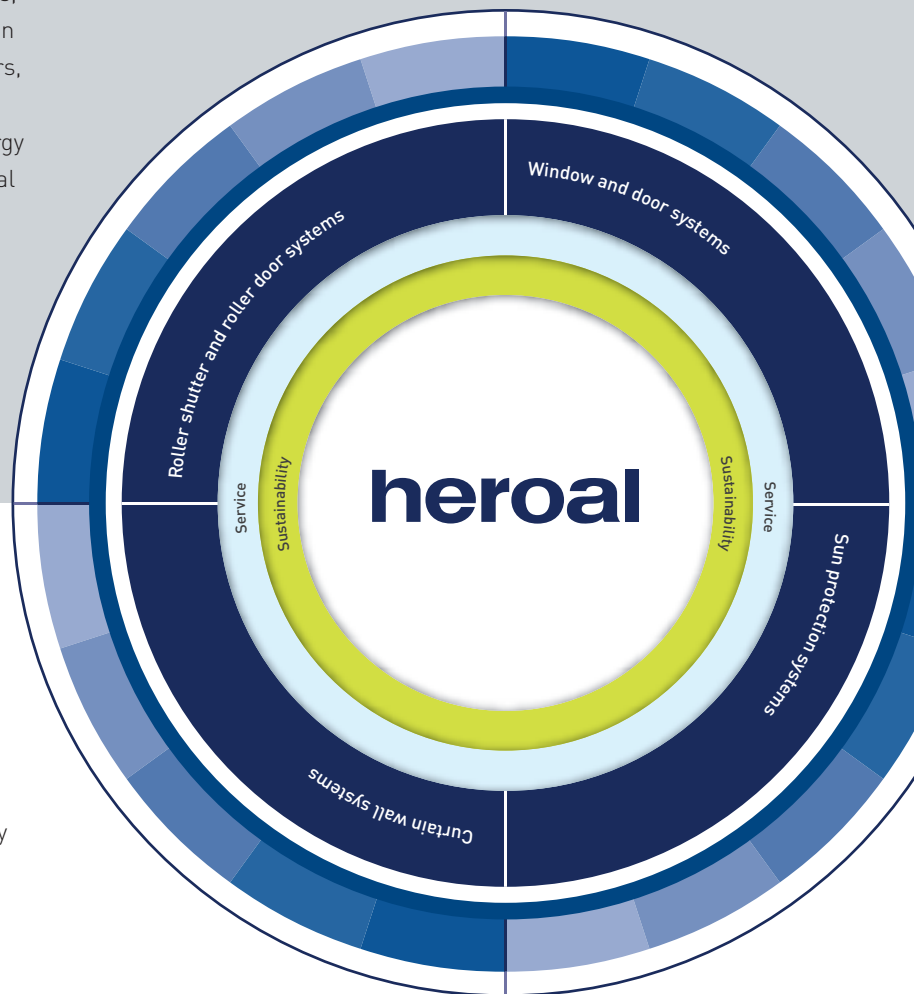

Roller shutters | Sun protection | Roller doors | Windows | Doors | Curtain walls | Service

heroal – Johann Henkenjohann GmbH & Co. KG

Österwieher Str. 80 | 33415 Verl (Germany) | Tel. +49 5246 507-0 | Fax +49 5246 507-222 | www.heroal.com